

LED-Pinball-Display 10009/11/13

Board Part Number / Platinenbauteilenummer 2003006 / 2003007

Schematics - Schaltpläne

© 2003 by PinLED

Contents - Inhalt

Page 3 / Seite 3.....	Strobes / Stellen.....	10009 and 10011
Page 4 / Seite 4.....	Strobes / Stellen.....	10013
Page 5 / Seite 5.....	Digits / Segmente.....	10009 and 10011
Page 6 / Seite 6.....	Digits / Segmente.....	10013
Page 7 / Seite 7.....	Board / Platine.....	10009
Page 8 / Seite 8.....	Board / Platine.....	10011
Page 9 / Seite 9.....	Board / Platine.....	10013

!!!!!! CAUTION / VORSICHT !!!!!!

**Ensure that the HIGH VOLTAGE FUSES are removed
from the Power Supply Board !**

**Stellen Sie sicher, dass die HOCHSPANNUNGSSICHERUNGEN
von der Spannungsversorgungsplatine entfernt sind !**

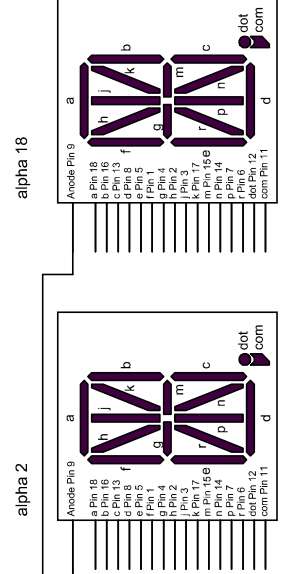
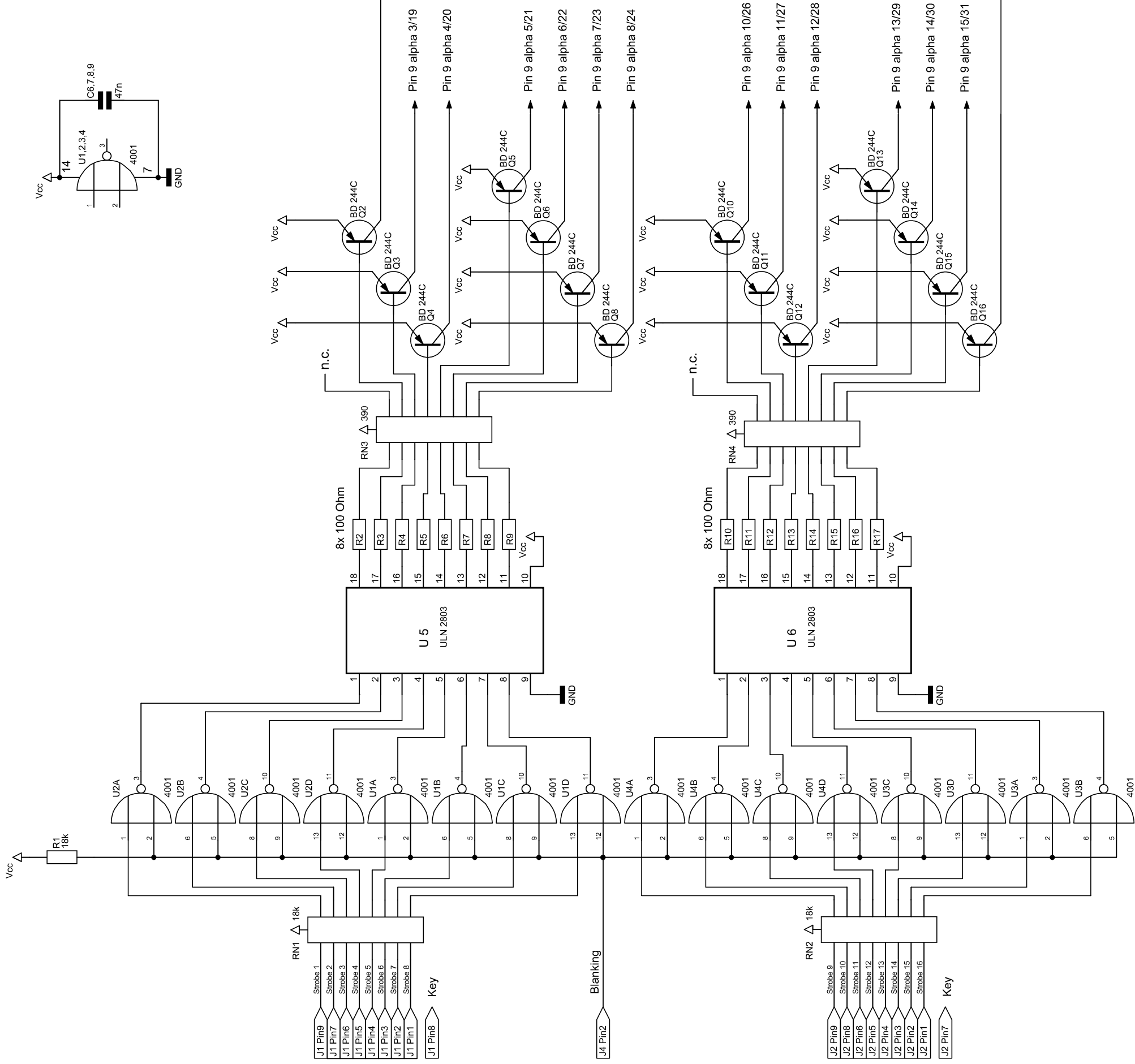
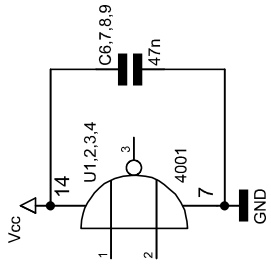
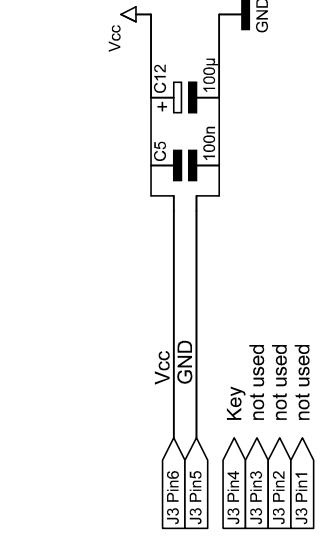

Displayorder/Displayanordnung (alpha)

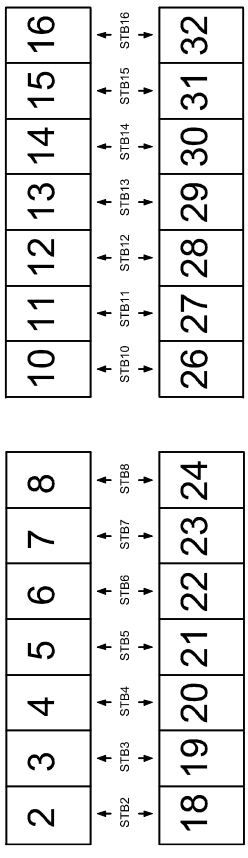

NOTE: Strobe 1 and 9 are not used !

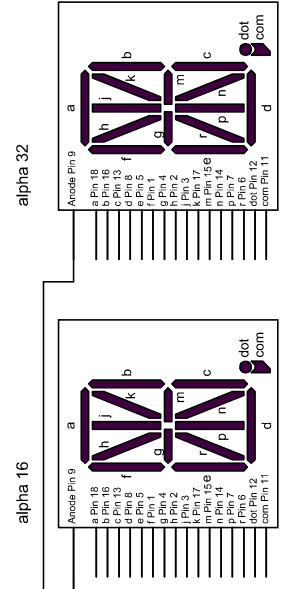

Notes: used in 10009 and 10011

Date: 07/14/03
Name: A.Förster
Copyright 2003
by A.Förster

Strobes

PinLED

PN: 2003006
Rev: 02
Boardname:
10009 and 10011

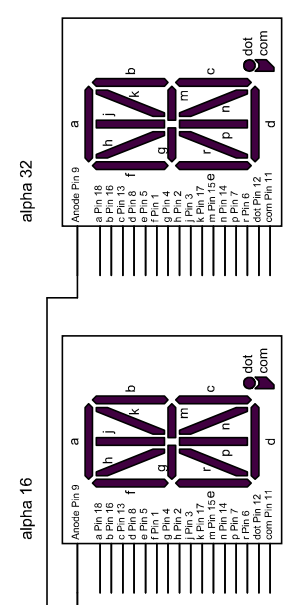
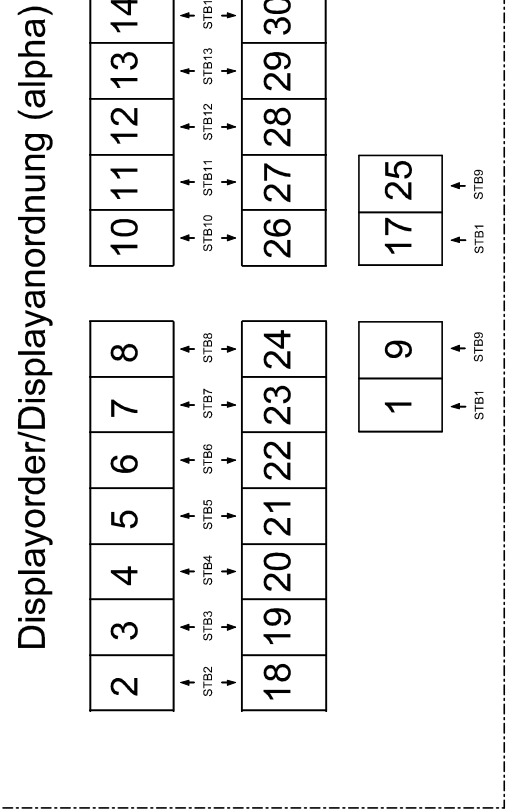
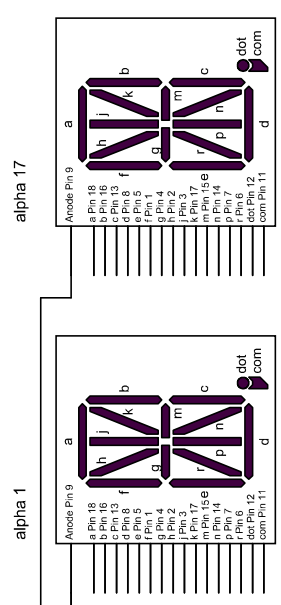
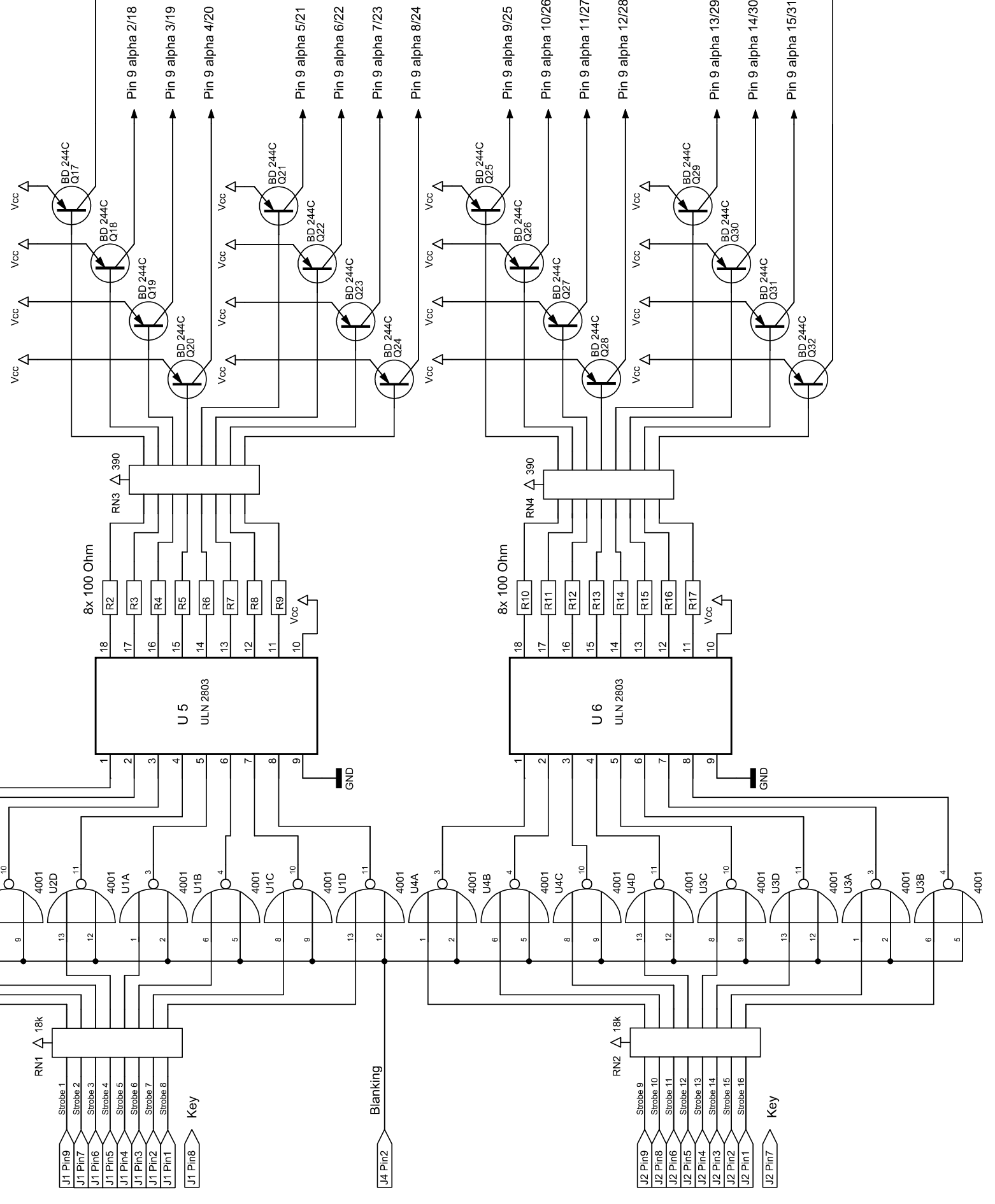
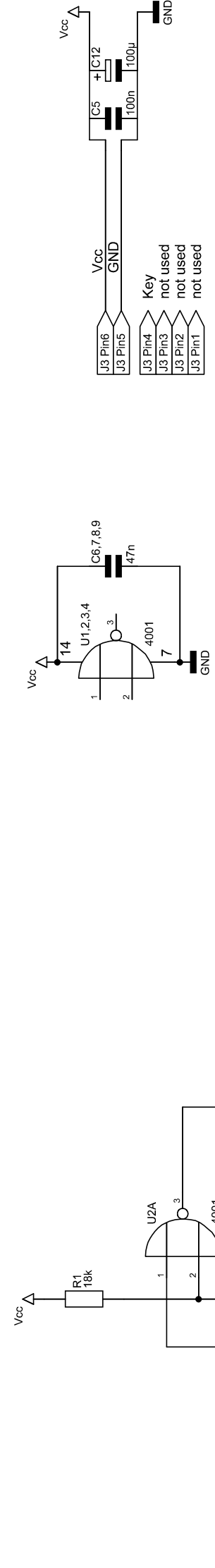

Notes: used in WILLIAMS Millionaire only (10013)

Date: 07/14/03

Name: A.Förster

Copyright 2003
by A.Förster

Strobes

PN: 2003007

Rev: 02

Boardname:
10013

PinLED

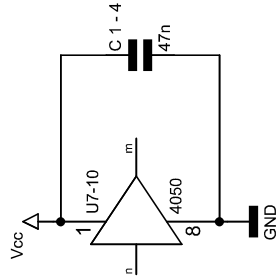
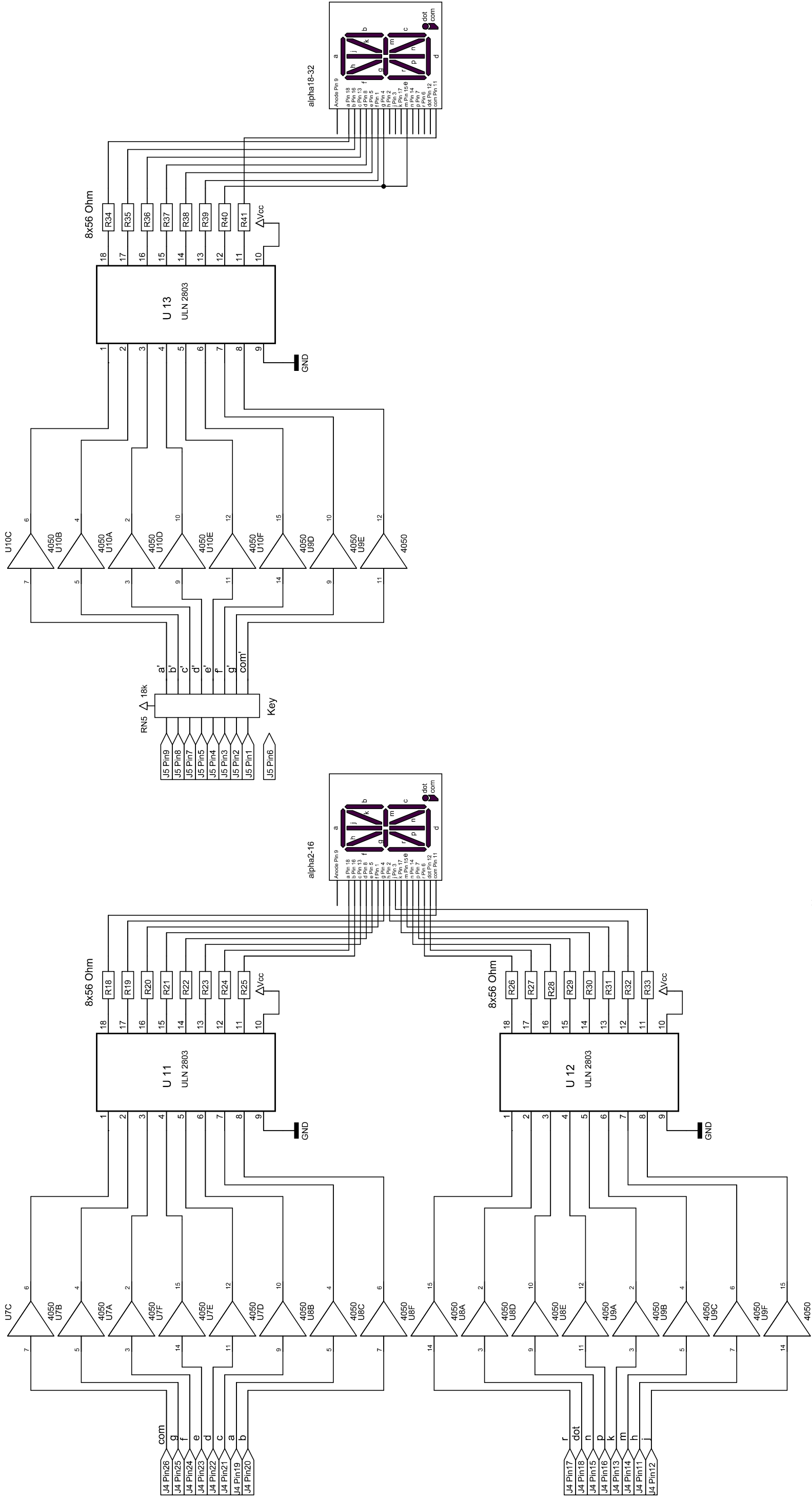

Notes:

Date: 07/16/03

Name: A.Förster

Copyright 2003
by A.Förster

Digits

PinLED

PN:2003006 / 7

Rev: 02

Boardname:
10009 and 10011

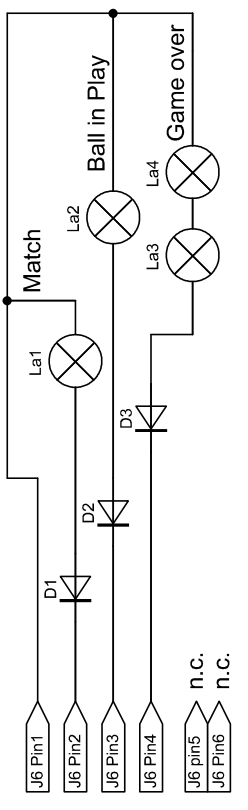
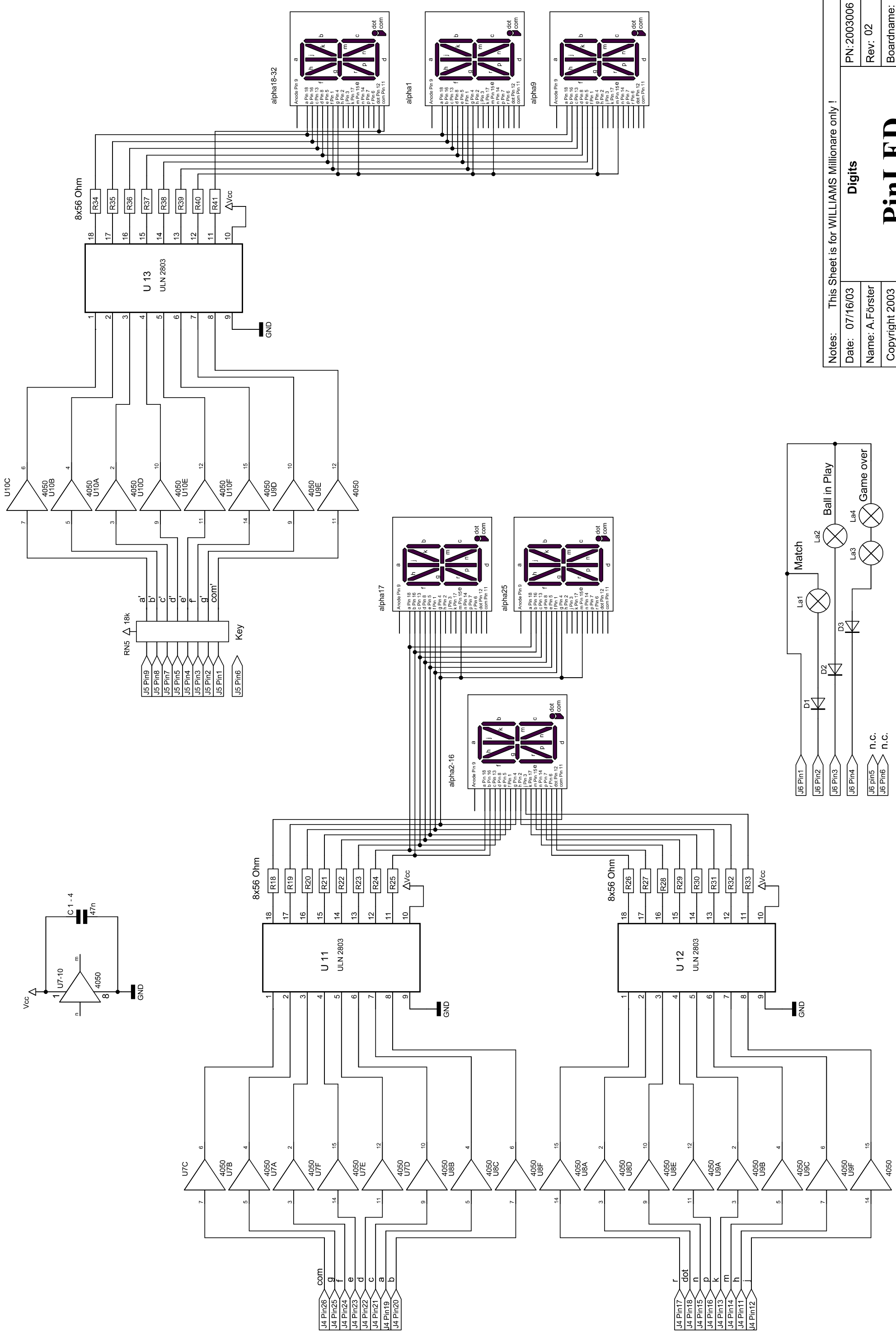

Notes: This Sheet is for WILLIAMS Millionaire only !
 Date: 07/16/03
 Name: A.Förster
 Copyright 2003
 by A.Förster

Digits

PinLED

PN:2003006 / 7
 Rev: 02
 Boardname:
 10013

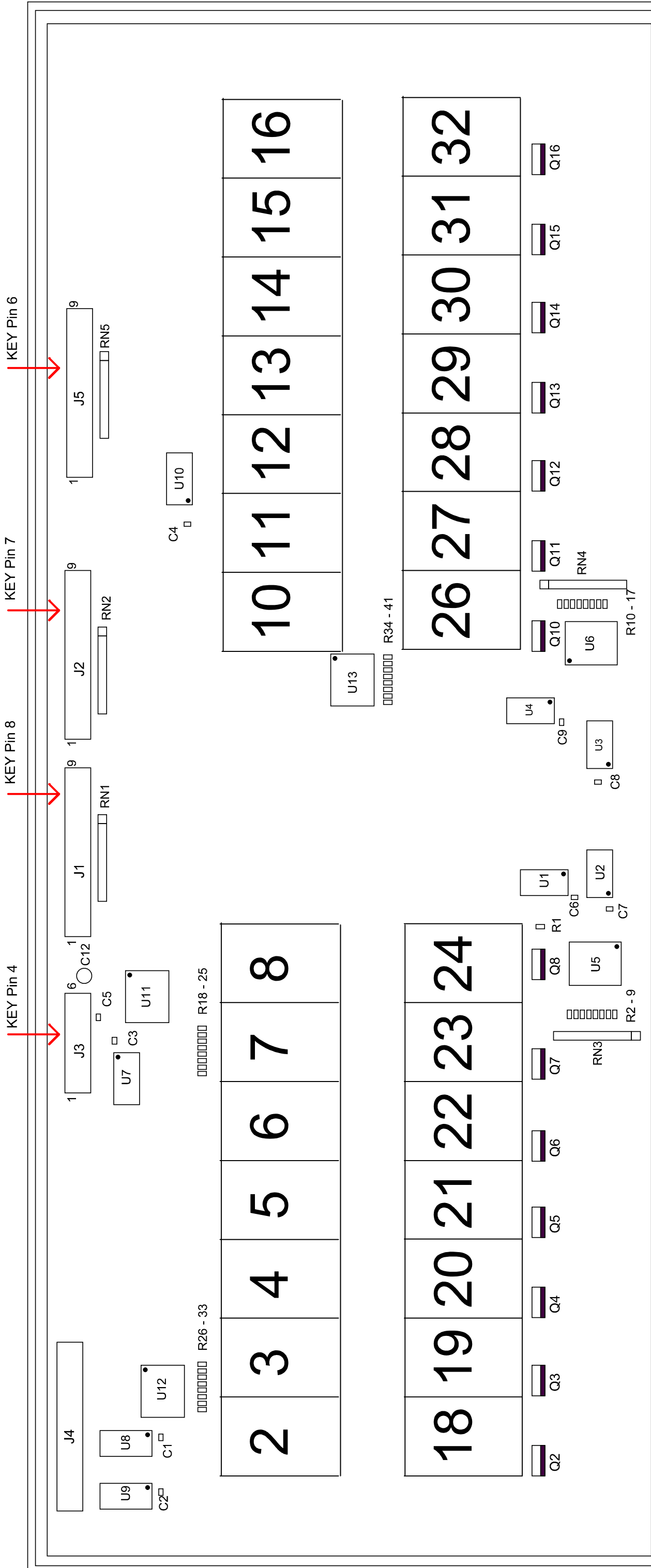

LED-Display Board PN: 2003006 10009

U1, U2, U3, U4.....	MOS 4001
U5, U6, U11, U12, U13.....	UDN 2803
U7, U8, U9, U10.....	MOS 4050
Q2, Q3, Q4, Q5, Q6, Q7, Q8, Q10	
Q11, Q12, Q13, Q14, Q15, Q16.....	BD 244C
C1, C2, C3, C4, C6, C7, C8, C9.....	47nF.....0805
C5.....	100nF.....0805
C12.....	100µF/16Volt
R1.....	18k Ohm.....1206
R2 - R 17.....	100 Ohm.....1206
R18 - R41.....	56 Ohm.....1206
RN1, 2, 5.....	18k Ohm.....SIL, 8R, 18k
RN3, 4.....	390 Ohm.....SIL, 8R, 390

All Resistors are 1/4 W.....Alle Widerstände 1/4 W

Notes: 10009 "F14 TomCat"	
Date: 12/08/03	PN: 2003006
Name: A.Förster	Rev: 02
Copyright 2003 by A.Förster	Boardname: 10009

PinLED

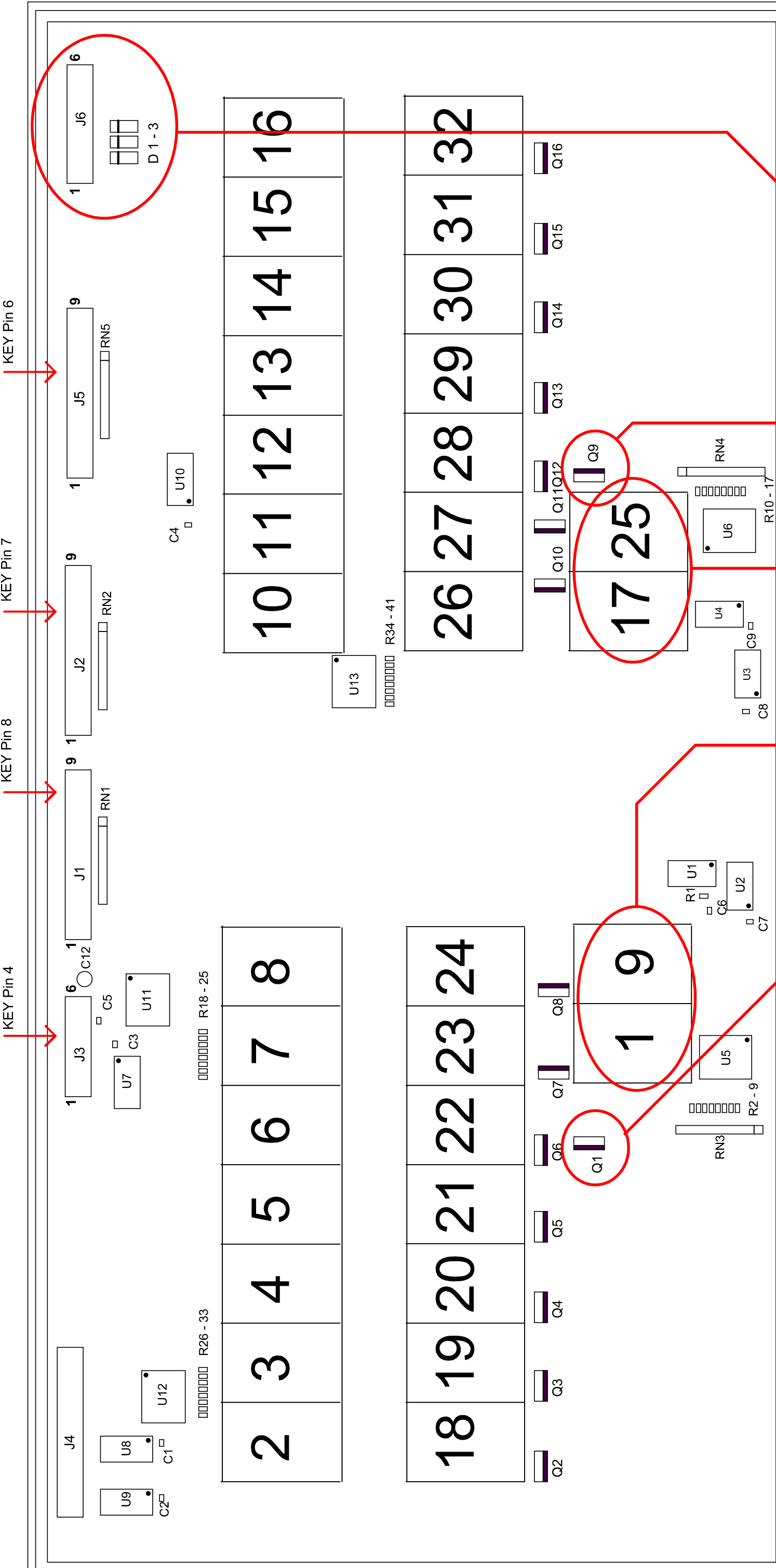

LED-Display Board PN: 2003007 10011

U1, U2, U3, U4.....	MOS 4001
U5, U6, U11, U12, U13.....	UDN 2803
U7, U8, U9, U10.....	MOS 4050
Q2, Q3, Q4, Q5, Q6, Q7, Q8,	
Q11, Q12, Q13, Q14, Q15, Q16.....	BD 244C
C1, C2, C3, C4, C6, C7, C8, C9.....	47nF.....0805
C5.....	100nF.....0805
C12.....	100µF/16Volt
R1.....	18k Ohm.....1206
R2 - R 17.....	100 Ohm.....1206
R18 - R41.....	56 Ohm.....1206
RN1, 2, 5.....	18k Ohm.....SIL, 8R, 18k
RN3, 4.....	390 Ohm.....SIL, 8R, 390

All Resistors are 1/4 W.....Alle Widerstände 1/4 W

Q1, Q9, J6, D1, D2, D3, LED1, LED9, LED17, und LED25 nicht be:

Notes: 10011 "F14 TomCat" groß	
Date: 12/26/03	PN: 2003007
Name: A.Förster	Rev: 03
Copyright 2003 by A.Förster	Boardname: 10011

PinLED

NO KEY

KEY Pin 6

KEY Pin 7

KEY Pin 8

KEY Pin 4

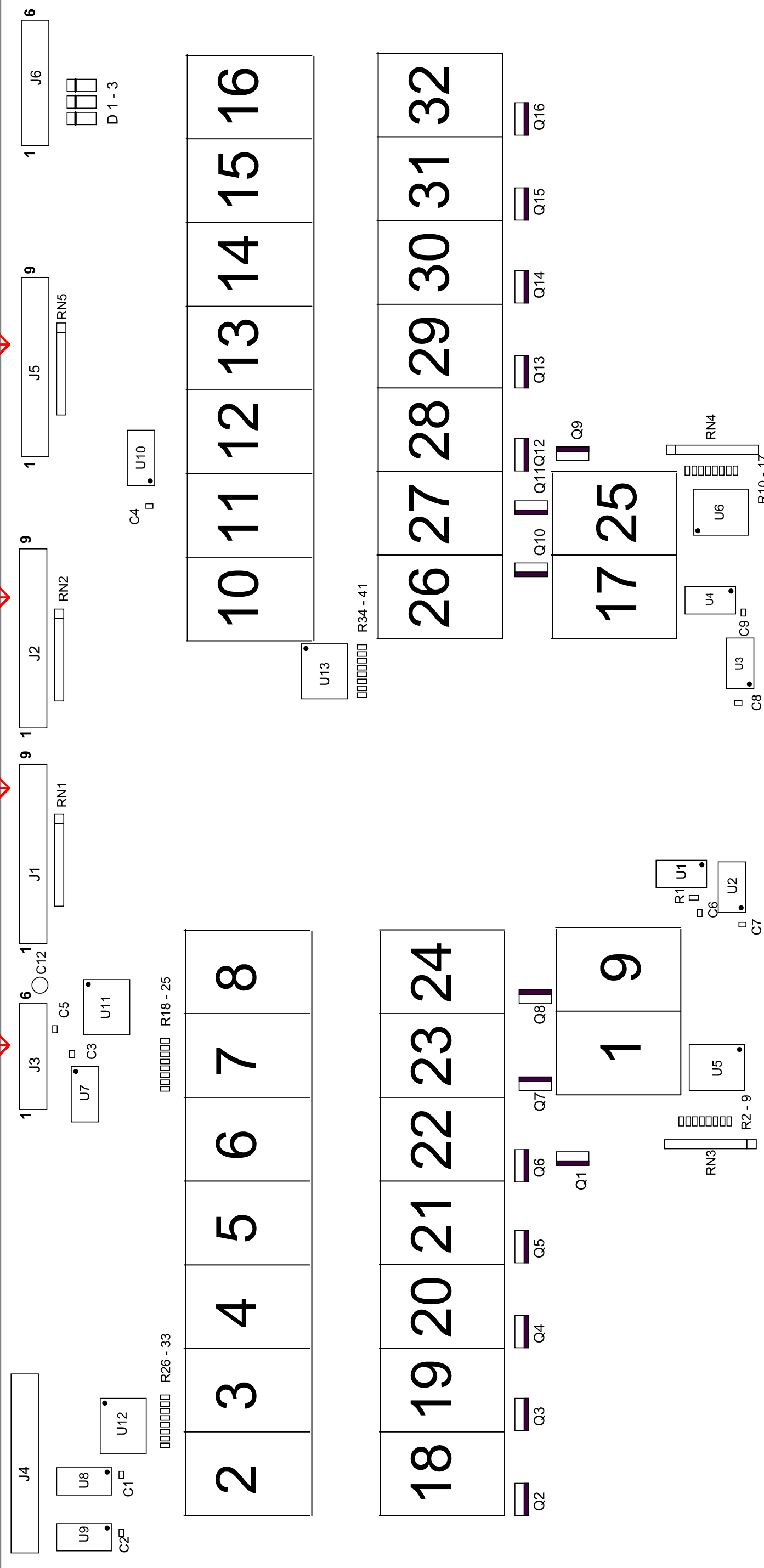

LED-Display Board PN: 2003007 10013

U1, U2, U3, U4.....	MOS 4001
U5, U6, U11, U12, U13.....	UDN 2803
U7, U8, U9, U10.....	MOS 4050
Q1, Q2, Q3, Q4, Q5, Q6, Q7, Q8, Q9	
Q10, Q11, Q12, Q13, Q14, Q15, Q16.....	BD 244C
C1, C2, C3, C4, C6, C7, C8, C9.....	.47nF.....0805
C5.....	.100nF.....0805
C12.....	100µF/16Volt
R1.....	.18k Ohm.....1206
R2 - R 17.....	100 Ohm.....1206
R18 - R41.....	.56 Ohm.....1206
RN1, 2, 5.....	.18k Ohm.....SIL, 8R, 18k
RN3, 4.....	.390 Ohm.....SIL, 8R, 390
D1 -3.....	1N4001
All Resistors are 1/4 W.....	Alle Widerstände 1/4 W

Notes: 10013 "Millionare"

Date: 04/16/03

Name: A.Förster

Copyright 2003 by A.Förster

PN: 2003007

Rev: 02

Boardname: 10013

PinLED