

16-50018-103
October 1992

WHITE WATER

Operator's Handbook

Including----

- Rubber Rings Locations
- Ramp Locations
- Playfield Parts Locations
- Solenoid Table and Locations
- Lamp Matrix and Locations
- Switch Matrix and Locations
- Main Menu Chart

Williams Electronics Games, Inc.
3401 N. California Ave.
Chicago. IL 60618

Rubber Rings

<u>Item</u>	<u>Part No.</u>	<u>Qty.</u>	<u>Description</u>
A	23-6300	4	5/16" Rubber Ring
B	23-6301	1	3/4" Rubber Ring
C	23-6302	1	1" Rubber Ring
D	23-6304	1	1-1/2" Rubber Ring
E	23-6305	2	2" Rubber Ring
F	23-6306	2	2-1/2" Rubber Ring

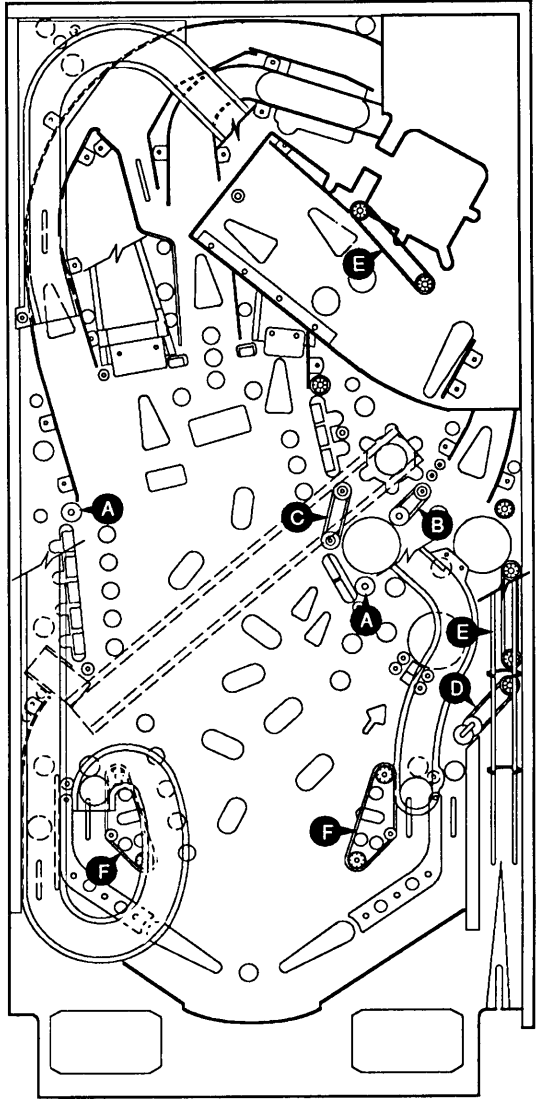

Ramps

Item	Part No.	Description
1	A-15838	Waterfall Ramp Assy.
1a)	5647-12693-21	Mini-Micro Switch
2	A-15840	Suicide Canyon Ramp Assy.
2a)	5647-12693-21	Mini- Micro Switch
2b)	A-14316	Photo Transistor Assy.
2c)	A-14315	LED Assy.
3	A-15830	Lower-to-Upper Ramp Assy
3a)	5647-12693-11	Mini-Micro Switch
3b)	A-14316	Photo Transistor Assy.
3c)	A-14315	LED Assy.
4	03-8693	Whirlpool Ramp Assy.
5	A-15837	Bigfoot Ramp Assy.
5a)	5647-12693-13	Mini-Micro Switch
5b)	5647-12693-21	Mini-Micro Switch
6	12-7049	Wire Ramp
7	12-7044	Wire Ramp
8	03-8694	Under Ramp Assy.
9	03-8691	Upper-to-Lower Ramp

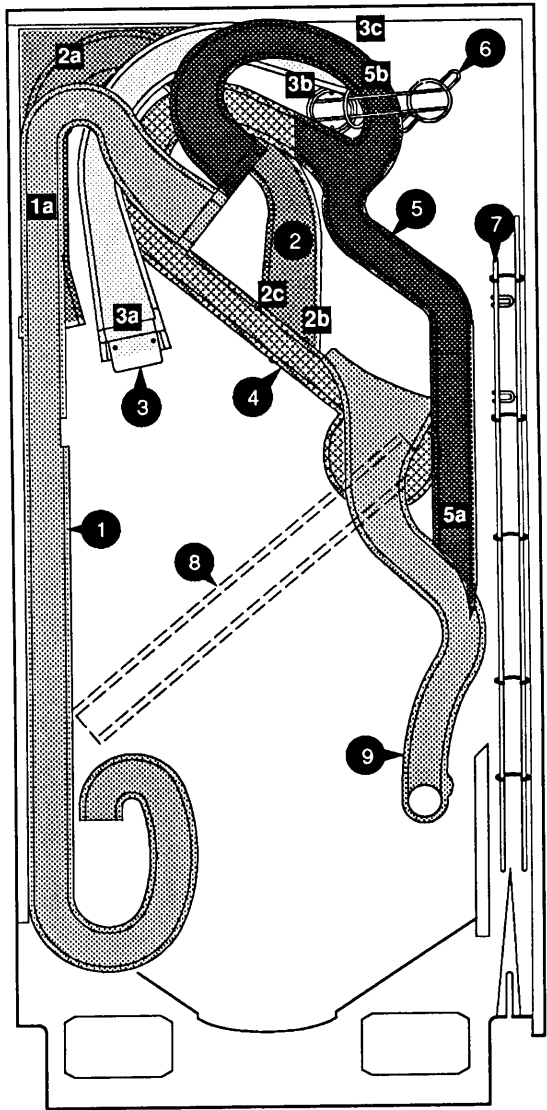

Lower Playfield Parts

Item	Part Number	Description
1.	A-15205-L	Lower Left Flipper
2.	A-15205-R	Lower Right Flipper
3.	B-8925	Micro Switch Plate Assembly
4.	C-9638	Multiball Eject Assembly
	10-128	Spring
	B-9362-R-3	Coil & Bracket Assy.
5.	01-10721	Safety Bracket (2 Used)
6.	B-12665	Kicker Arm (Slingshot) Assy. - R.
	A-14369-R	Coil & Bracket Assy.
	10-128	Spring
	B-8284-1	Kicker Switch Assembly
7.	A-15764	11-Lamp Board
8.	A-9415-2	Jet Bumper Coil Assy. (3 Used)
a)	B-12030-2	Switch & Diode Assy. (3 Used)
9.	A-15768	8-Lamp Board Assy.
10.	A-15829	Whirlpool Assembly
11.	03-8694	Under Ramp
12.	A-15767	12-Lamp Board
13.	A-15766	3-Lamp Board
14.	A-15421-1	Playfield Slide Assembly - R.
15.	A-15595	7-Opto Switch Board
16.	A-15926	Ball Popper & Multiball Assembly
a)	A-15769	Ball Popper & Opto Assy.
b)	A-15927	Multiball Trough Assy.
17.	A-15782	Bi-Directional Board
18.	A-15421-1	Playfield Slide Assy., Left
19.	A-15763	5-Lamp Board
20.	A-15758	Whirlpool Eject Assembly
21.	B-12665	Kicker Arm (Slingshot) Assy. - L.
a)	A-15749	Coil & Bracket Assy.
b)	10-128	Spring
c)	B-8284-1	Kicker Switch Assembly
22.	01-10726	Rear Guide Leg (2 Used)

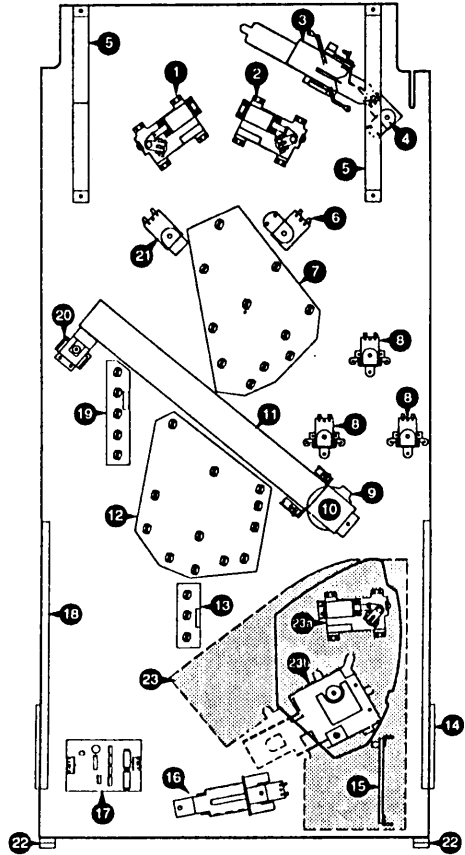

Underside of Playfield, Viewed in Raised Position

Mini-Playfield Lower Parts:

23.	A-15772	Upper Mini-Playfield
a)	A-15843	Electronic Flipper Assembly
b)	A-15573	Big Foot Mech. Assembly

Upper Playfield Parts

<u>Item</u>	<u>Part Number</u>	<u>Description</u>
1	A-8039-3	Outhole
2	B-8925	Microswitch Plate
3	B-9362-R-3	Coil & Bracket Assembly
4	20-9250-5	Flipper Paddle & Shaft
5	A-16082-1	Right Flipper Ball Guide
6	A-14369-R	Coil & Bracket Assembly
7	12-7044	Wire Ramp Shoot
8	A-14604-12	Oblong Target, Orange
9	B-12912-24	Oblong Target, White
10	B-9414	Jet Bumper Assembly
10a)	A-9415-2	Coil & Bracket Assembly
11	B-12912-23	Standup Target, Red
12	01-10901	Ball Guide
13	01-10906	Ramp Flap
14	A-15772	Upper Mini Playfield
14a)	20-9250-5	Flipper Shaft & Paddle
14b)	01-10855	Ball Guide
14c)	01-10844	Upper Ball Guide
14d)	A-15573	Bigfoot Mech. Assembly
14e)	01-10843	Bigfoot Ball Guide
14f)	01-10841	Ball Guide
14g)	12-7049	Ball Guide
14h)	01-10842	Fence Ball Guide
15	A-15926	Ball Popper & Multi Ball Trough
15a)	A-15927	Multi Ball Trough
16	12-7052	Boomerang Wire
17	12-7051	Boulder Wire
18	01-10852	Ball Guide
19	01-10850	Ball Guide
20	A-14604-11	Standup Target, Green
21	B-12912-10	Standup Target, Blue
22	01-10845	Bottom Ball Guide
23	A-15749	Coil & Bracket Assembly
24	B-12919	Left Flipper Guide
25	12-6466-45	Wireform
26	20-9250-5	Flipper Shaft & Paddle
27	B-11873	Bottom Arch Kicker
28	12-7063	Wireform

Not Shown

A-13204-50018	Bottom Arch Assembly
16-50018-1	Instruction Card
20-9041	Tinnerman Speednut
20-9045	Instruction Card Cover
23-6313-1	Rubber Grommet
31-1008-50018	Screened Bottom Arch
A-15878	Flipper Cabinet Switch
01-3569-1	Ball Return Runway
03-8801-1*	Full Lower Playfield Mylar
03-8801-2	Jet Bumper Mylar
03-8801-3	Full Upper Playfield Mylar
03-8801-4	Upper Ball Popper Mylar
03-8801-5	Right Return Lane Mylar
03-8801-6	Left Return Lane Mylar
20-6500	Steel Ball

* The White Water Diamond Plate™ playfield does not require a full mylar. However, mylars can be purchased through your local Williams Distributor

Upper Parts Location

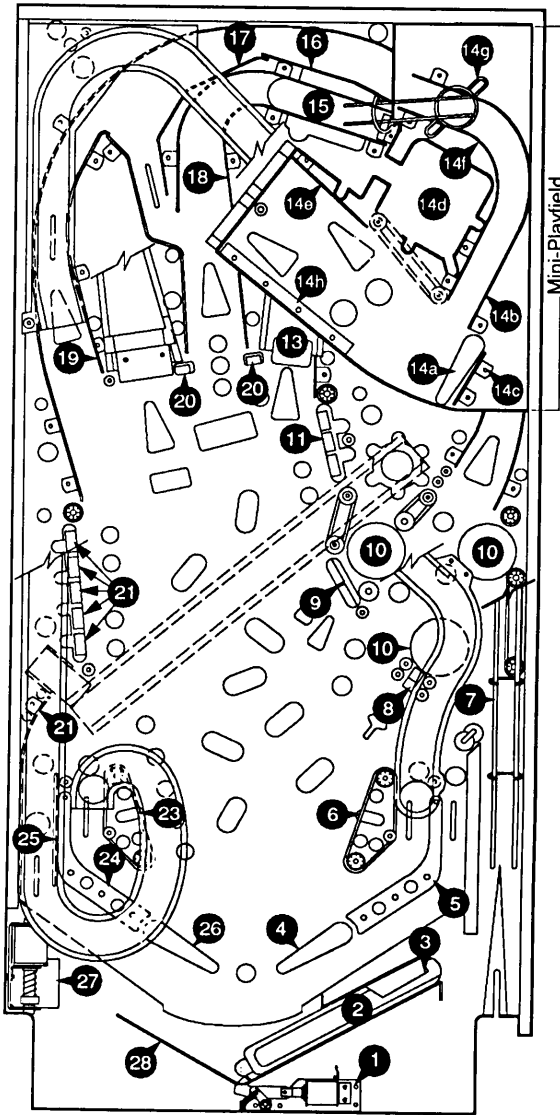

Solenoid/Flasher Table

Sol. No.	Function	Solenoid Type	Voltage Connections		Drive Motor	Drive Connections		Drive Wire Color	Solenoid Part Number	
			Playfield	Backbox		Playfield	Backbox			Playfield
01	Outball	High Power	J107-3		O82	J130-1		Vio-Brn	AE-27-1200	
02	Ball Serve	High Power	J107-3		O80	J130-2		Vio-Red	AE-26-1200	
03	Whirlpool Popper	High Power	J107-3		O78	J130-4		Vio-Grn	AE-26-800	
04	Lockup Popper	High Power	J107-3		O76	J130-5		Vio-Yel	AE-23-800	
05	Kickback	High Power	J107-3		O64	J130-6		Vio-Grn	AE-23-800	
06	Ramp Diverter	High Power	J107-3		O66	J130-7		Vio-Blu	AE-26-1200	
07	Knocker	High Power	J107-3		O68	J130-8		Vio-Blk	AE-23-800	
08	Backglass (2)	High Power		J106-5	O70		J131-5	Vio-Grn	(2) #906	
09	Wet Willie Head	Low Power		J106-5	O58		J129-1	Brn-Blk	(1) #906	
10	Left Slings	Low Power	J107-2		O56			Brn-Red	AE-27-1200	
11	Right Slings	Low Power	J107-2		O54	J127-4		Brn-Org	AE-27-1200	
12	Left Jet Bumper	Low Power	J107-2		O52	J127-5		Brn-Yel	AE-26-1200	
13	Right Jet Bumper	Low Power	J107-2		O50	J127-6		Brn-Grn	AE-26-1200	
14	Center Jet Bumper	Low Power	J107-2		O48	J127-7		Brn-Blu	AE-26-1200	
15	Backglass Flair	Low Power		J108-5	O46		J128-3	Brn-Vio	(2) #906	
16	Backglass Pickers	Low Power		J108-5	O44		J128-5	Brn-Grn	(2) #906	
17	Bigfoot Body	Flasher	J107-6		O42	J128-1		Blk-Grn	(1) #89	
18	Right Mountains	Flasher	J107-6		O40	J128-1	J125-1	Blk-Red	(1) #89	
19	Left Mountains	Flasher	J107-6		O38	J128-3	J125-2	Blk-Org	(1) #89	
20	Upper Left Playfield	Flasher	J107-6		O36	J128-4	J125-5	Blk-Yel	(1) #89	
21	Insanity Falls	Flasher	J107-6		O28	J128-5		Blu-Grn	(1) #89	
22	Whirlpool Popper	Flasher	J107-6		O30	J128-6		Blu-Blk	(1) #89	
23	Whirlpool Enter	Flasher	J107-6		O34	J128-7		Blu-Vio	(1) #89	
24	Bigfoot Cave	Flasher	J107-6		O32	J128-8	J125-9	Blu-Grn	(1) #89	
25	Bigfoot Drive	Low Power	J118-2,3		O26	J122-1		Blu-Brn	A-15680	
26	Bigfoot Enable	Low Power	J118-2,3		O24	J122-2		Blu-Red	A-15680	
27	Chase Lamp Check	Low Power	J105-4,5; J118-2,3		O22		J123-4	Blk-Grn	A-15261	
28	Chase Lamp Data	Low Power	J105-4,5; J118-2,3		O20		J123-5	Blu-Yel	A-15261	
01	General Illumination	G.I.	Playfield	Backbox <td>Cabinet</td> <td>Playfield</td> <td>Backbox</td> <td>Cabinet</td> <td>Playfield</td> <td>Backbox</td>	Cabinet	Playfield	Backbox	Cabinet	Playfield	Backbox
02	Playfield Center	G.I.	J120-1	J120-7	J121-9	O18	J120-7	J121-9	Wht-Brn	#44
03	Playfield Lower	G.I.	J120-2	J121-3		O10	J120-8	J121-10	Wht-Org	#44
04	Backglass Boat	G.I.	J120-3	J121-5		O14	J120-9	J121-11	Wht-Yel	#555
05	Backglass Sky	G.I.		J121-6	J119-3	O16			Wht-Grn	#555
	Flipper Circuits	Flipper	Playfield	Pwr	Hold	Playfield	Pwr	Hold	Blu-Vio	Org-Grn
	Upper Right Flipper	Flipper	J907-8,9 (Blu-Yel)	O4	O11	J902-11,13	FL-11629		Blk-Yel	Org-Vio
	Upper Left Flipper	Flipper	J907-4,5 (Blu-Yel)	O2	O7	J902-4,6	FL-11630		Blu-Grn	Org-Blu
	Lower Left Flipper	Flipper	J907-6,7 (Gny-Yel)	O3	O9	J902-7,9	FL-11629			

Solenoid Locations

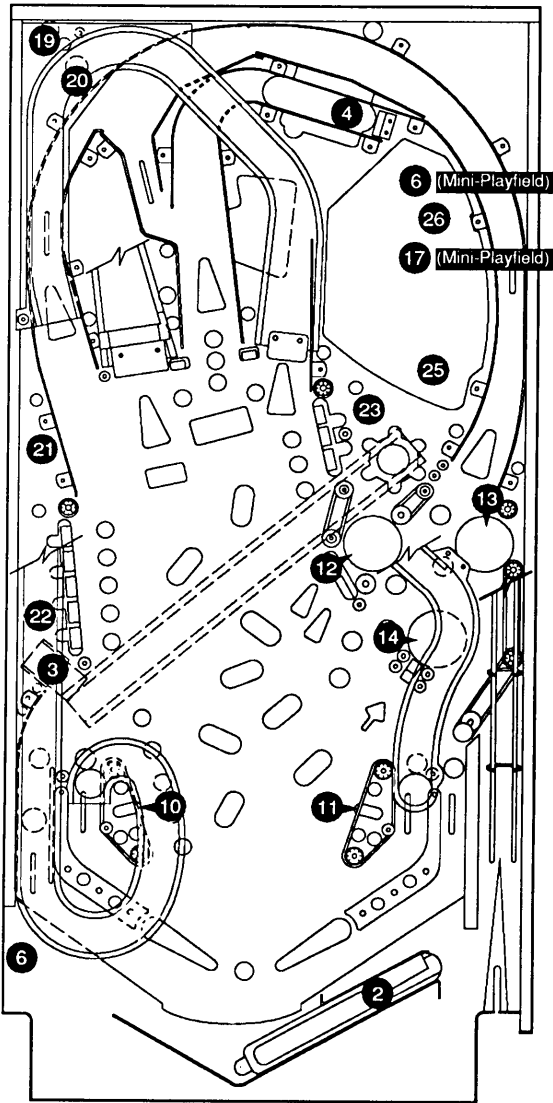

Lamps

Lamp Matrix								
		Red			Yellow (B-)			
Column	1	2	3	4	5	6	7	8
Row	Yellow-Brown J137-1 QB8	Yellow-Red J137-2 QB7	Yellow-Orange J137-3 QB6	Yellow-Black J137-4 QB5	Yellow-Green J137-5 QB4	Yellow-Blue J137-6 QB3	Yellow-Violet J137-7 QB2	Yellow-Gray J137-8 QB1
1	Red-Brown J133-1 QB0	Shoot Again 11	River "R1" 21	Rail 7 31	3-Bank Center 41	Hazzard 1 51	Whirpool 1 71	Light Extra Ball 81
2	Red-Black J132-2 QB9	Kickback 12	River "1" 22	Rail 8 32	3-Bank Lower 42	Hazzard 5 52	Whirpool 2 72	Advance Rail 1 82
3	Red-Orange J132-4 QB8	Left Outlane 13	River "V" 23	Wet Wills 33	Lock Release 43	Hazzard 6 53	Whirpool 3 73	Mystery 1 83
4	Red-Yellow J132-5 QB7	Left Flipper Lane 14	River "E" 24	Ramp Millions 34	3-Bank Top 44	Hazzard 7 54	Whirpool 4 74	Boulder 5X Award 1 84
5	Red-Green J132-6 QB6	Right Flipper Lane 15	River "R2" 25	Hazzard 4 35	Hazzard 4 45	Not Used 1 55	Whirpool 5 75	Not Used 1 85
6	Red-Blue J132-7 QB5	Right Outlane 16	Hazzard 3 26	Left Light Lock 36	Right Light Lock 46	Extra Ball 1 56	Whirpool 6 76	Not Used 1 86
7	Red-Violet J132-8 QB4	Not Used 17	Lock 1 27	2X Multiplier 37	4X Multiplier 47	Whirl Challenge 1 57	Multi Jackpot 1 77	Not Used 1 87
8	Red-Gray J132-9 QB3	6X Multiplier 18	Lock 2 28	3X Multiplier 38	5X Multiplier 48	Boulder Man Over 1 58	Bigfoot Jackpot 1 78	Start Button 1 88

Lamp Locations

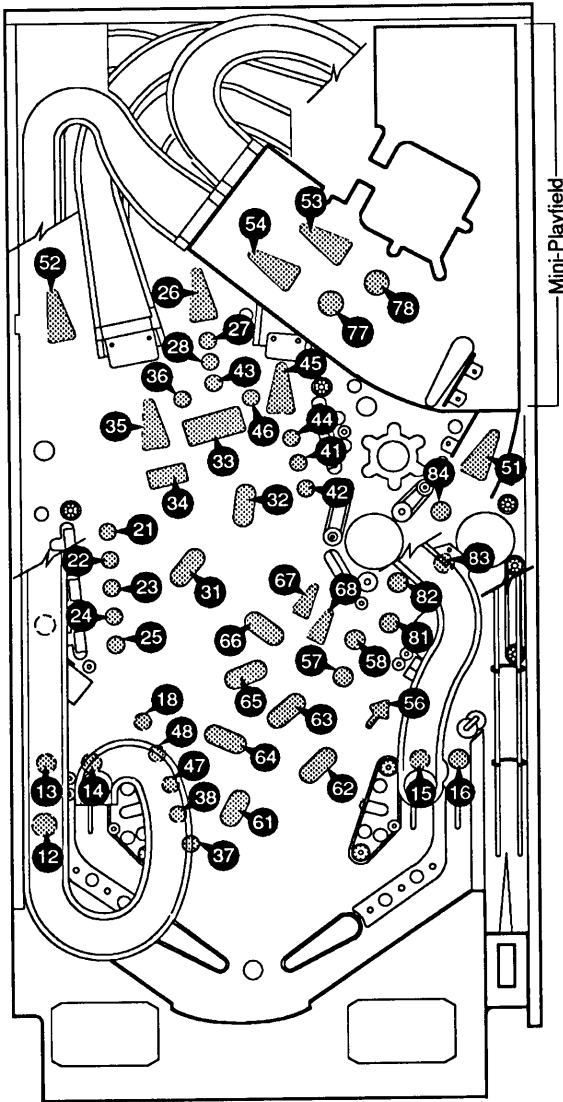

Switches

Dedicated Grounded Switches		Switch Matrix										Dedicated Grounded Switches
		Column	1	2	3	4	5	6	7	8	Row	
Orange-Brown J205-1 Left Coin Chute	D1	White-Brown J209-1 U18-11	Not Used	Stair Tilt	River "RZ"	Light Lock Left	Left Sling	Whirlpool Popper	Rapids Ramp Main	Not Used	Black-Green J806-1 Lower Right E.O.S. Switch	E1
Orange-Red J205-2 Center Coin Chute	D2	White-Red J209-2 U18-9	Not Used	Coin Door Closed	River "E"	Light Lock Right	Right Sling	Whirlpool Exit	Not Used	Blue-Violet J805-1 Lower Right Flipper Button	E2	
Orange-Black J205-3 Right Coin Chute	D3	White-Orange J209-3 U18-5	Start Button	Ticket Opto.	River "V"	Left Loop	Ball Shooter	Lockup Right	Hot Foot Upper	Not Used	Black-Blue J805-3 Lower Left E.O.S. Switch	F3
Orange-Yellow J205-4 Fourth Coin Chute	D4	White-Yellow J209-4 U18-7	Plumb Bob TR	Always Closed	River "T"	Right Loop	Lower Jet Arena	Lockup Center	Hot Foot Lower	Not Used	Black-Gray J805-2 Lower Left Flipper Button	F4
Orange-Green J205-5 Test Function Syringe Ejection Credits	D5	White-Green J209-5 U18-11	Outhole	Left Outlane	River "R1"	Secret Passage	Right Jet Arena	Lockup Left	Disas. Drop Main	Not Used	Black-Violet J805-4 Upper Right E.O.S. Switch	F5
Orange-Blue J205-7 Test Function Volume Down	D6	White-Blue J209-7 U18-9	Left Jet Bumper	Left Flipper Lane	3-Bank Top	Left Ramp Enter	Extra Ball	Left Ramp Main	Right Trough	Big/Col Opto 1	Black-Yellow J805-3 Upper Right Flipper Button	F6
Orange-Violet J205-8 Test Function Volume Up	D7	White-Violet J209-8 U18-5	Right Jet Bumper	Right Flipper Lane	3-Bank Center	Rapids Enter	Canyon Main	Not Used	Center Trough	Big/Col Opto 2	Black-Gray J805-5 Upper Left E.O.S. Switch	F7
Orange-Grey J205-9 Test Function Begin Enter	D8	White-Grey J209-9 U18-7	Center Jet Bumper	Right Outlane	3-Bank Lower	Canyon Entrance	Big/Col Cave	Disas. Drop Enter	Left Trough	Not Used	Black-Blue J805-6 Upper Left Flipper Button	F8

Switch Locations

MAIN PLAYFIELD

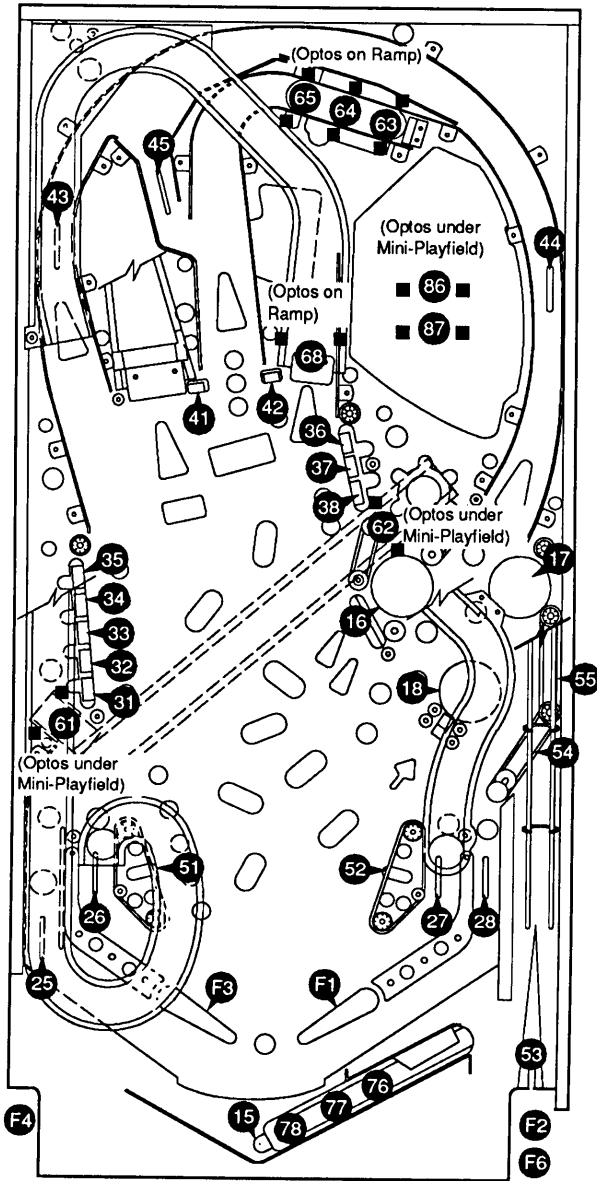

Switch Location

UPPER PLAYFIELD

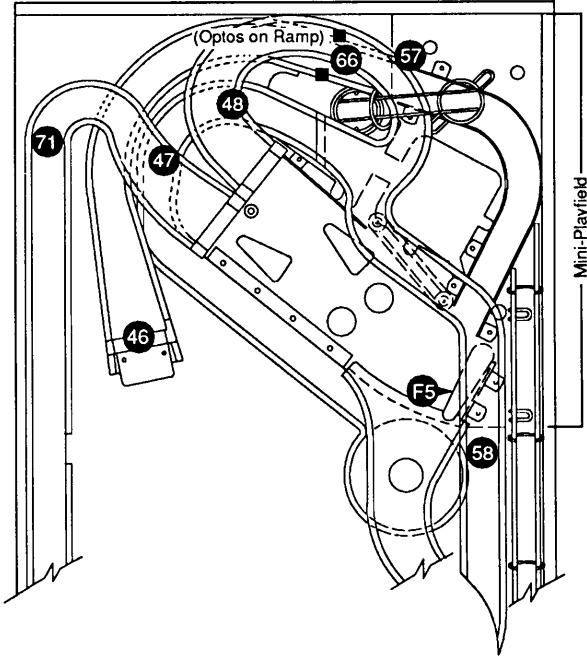

Main Menu

Main Menu

B. Bookkeeping Menu

- B.1 Main Audits
- B.2 Earning Audits
- B.3 Standard Audits
- B.4 Feature Audits
- B.5 Histograms
- B.6 Time-stamps

Press Escape

To move out of a menu selection.

Press Enter

To get into a menu selection.

Press Up

Increases sequence; (ex. A.1, A.2, A.3, A.4).

Press Down

Decreases sequence; (ex. A.4, A.3, A.2, A.1).

P. Printouts Menu

- P.1 Earnings Data
- P.2 Main Audits
- P.3 Standard Audits
- P.4 Feature Audits
- P.5 Score Histograms
- P.6 Time Histograms
- P.7 Time-Stamped
- P.8 All Data

Use Up or Down to cycle through the selections in a menu.

Use Escape and Enter to move into and out of the selected menu.

T. Test Menu

- T.1 Switch Edges
- T.2 Switch Levels
- T.3 Single Switches
- T.4 Solenoid Test
- T.5 Flasher Test
- T.6 General Illumination
- T.7 Sound and Music Test
- T.8 Single Lamps
- T.9 All Lamps
- T.10 Lamp & Flasher Test
- T.11 Display Test
- T.12 Flipper Coil Test
- T.13 Bigfoot Test
- T.14 Backbox Test

U. Utilities Menu

- U.1 Clear Audits
- U.2 Clear Coins
- U.3 Reset H.S.T.D.
- U.4 Set Time & Date
- U.5 Custom Message
- U.6 Set Game I.D.
- U.7 Factory Adjustments
- U.8 Factory Resets
- U.9 Presets
- U.10 Clear Credits
- U.11 Auto Burn-in

A. Adjustments Menu

- A.1 Standard Adjustments
- A.2 Feature Adjustments
- A.3 Pricing Adjustments
- A.4 H.S.T.D. Adjustments
- A.5 Printer Adjustments

WARNINGS & NOTICES

WARNING

FOR SAFETY AND RELIABILITY, substitute parts and equipment modifications are not recommended. Use of Non-WILLIAMS parts or modifications of game circuitry, may adversely affect game play, or may cause injuries.

SUBSTITUTE PART OR EQUIPMENT MODIFICATIONS may void FCC Type Acceptance.

BECAUSE THIS GAME IS PROTECTED by Federal copyright, trademark, and patent laws, unauthorized game conversions may be illegal under Federal law.

THIS 'CONVERSION' PRINCIPLE ALSO APPLIES to unauthorized facsimiles of WILLIAMS equipment, logos, designs, publications, assemblies, and games (or game feature not deemed to be public domain), whether manufactured with WILLIAMS components or not.

NOTICE

WILLIAMS, Lane-change and Multi-ball are trademarks of WILLIAMS ELECTRONICS GAMES, INC. Entire contents of this manual © 1992 WILLIAMS ELECTRONICS GAMES, INC.

WARNING

Note: This equipment has been tested and found to comply with the limits for a Class A digital device, pursuant to Part 15 of the FCC Rules. These limits are designed to provide reasonable protection against harmful interference when the equipment is operated in a commercial environment. This equipment generated, uses, and can radiate radio frequency energy and if not installed and used in accordance with the instruction manual, may cause harmful interference to radio communications. Operation of this equipment in a residential area is likely to cause harmful interference in which case the user will be required to correct the interference at his own expense.

RF Interference Notice

CABLE HARNESS PLACEMENTS and ground strap routing on this game have been designed to keep RF radiation and conduction within levels accepted by the FCC Rules.

TO MAINTAIN THESE LEVELS, reposition harnesses and reconnect ground straps to their original placements, if they become disconnected during maintenance.

FCC STICKER. Check the back of your game to verify that an FCC-certification sticker was attached to your game at the factory. All games that leave the WILLIAMS plant have been tested and found to comply with FCC Rules. Because the sticker is proof of this fact, legal repercussions to the owner and distributor may result, if the sticker is missing. If you receive a game, manufactured after December 1982, that has no FCC sticker, call WILLIAMS for advice or write us a note on your Game Registration Card. Be sure that the card bears your game's serial number.



CAUTION

**Transport this game ONLY
with hinged backbox DOWN!**

FOR SERVICE... CALL your authorized WILLIAMS Distributor.